

S 32 S - C T
 1 2 3 4 5

1 Tipo da Barra / Type of Bar / Tipo de Barra

S	Barra sólida de aço	Solid Steel bar	Barra de acero enteriza
A	Barra de aço com refrigeração interna	Solid steel bar with coolant hole	Barra de acero con suministro refrigerante interno
C	Barra com haste de metal duro	Carbide bar with steel head	Barra con mango de metal duro

2 Diâmetro da Barra / Bar diameter / Diámetro de barra

3 Comprimento / Length / Longitude

K	125	U	350
M	150	V	400
Q	180	W	450
R	200	Y	500
S	250	X	Special
T	300		

4 Sistema de Fixação / Clamping System / Sistema de Sujeción

Fixação por Alanca Lever Lock Type Sujeción por Palanca	Fixação por Parafuso Screw Clamp Type Fijación por Tornillo
P	S
Fixação por Cunha-Grampo Wedge Clamp Type Sujeción por Brida cunha	Fixação por Grampo Top Clamp Type Sujeción por Brida Superior
M	C



TORNEAMENTO INTERNO

INTERNAL TOOLHOLDERS

TORNEADO INTERNO

F 6 P 7 R 8 - 16 - 10

5

- Formato do Inserto
- Insert Shape
- Forma de Plaqueta

W	S	T
C	D	E
K	V	R

6

- Ângulo de Ataque
- Approach Angle
- Forma de Barra

F	
K	
L	
Q	
U	
Z	

7

- Ângulo de Folga
- Insert Clearance Angle
- Ângulo de Incedencia

N	B
C	P

8

- Sentido da Ferramenta
- Hand of Tool
- Sentido de la herramienta

R	
L	

9

- Comprimento da aresta de corte
- Cutting Edge Length
- Longitud de arista de corte

R	S	T
C,D E,V	W	K

10

- Opções do Fabricante
- Manufacture's Option
- Opción del fabricante

- Código opcional do fabricante
- Optional code of the manufacturer
- Código opcional del fabricante









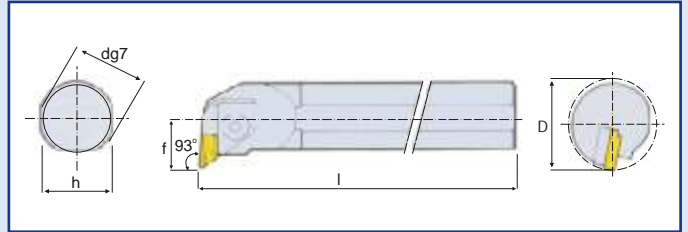
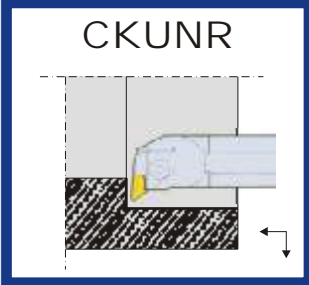



























 Fixação por Grampo

 Top Clamp Type

 Sujeción por Brida Superior









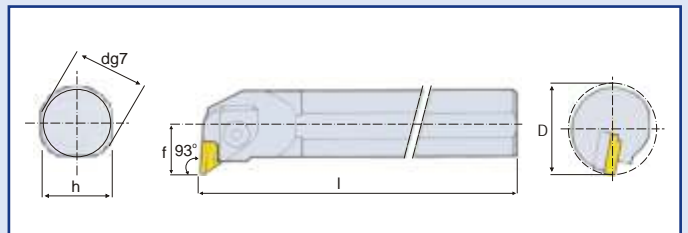
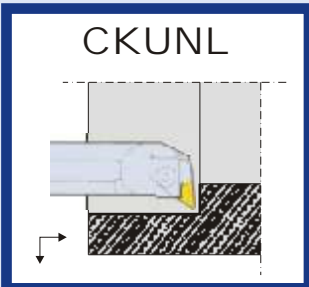



























CKUNR



 Código  Code  Código	 Dimensão (mm)  Dimension  Dimensiones					 Inserto  Insert  Plaquita	 Componentes  Components		 Accesorios			
	d	h	f	l	D _{min.}		 Grampo R  Wedge R  Brida R	 Parafuso  Screw  Tornillo	 Chave  Wrench  Llave	 Mola  Spring  Resorte	 Calço R  Shim Right  Pl. Apoyo R	 Rebite  Shim Pin  Pasador
S32U CKUNR 16	32	30	22	350	44	KN__16	 170.5-825	 170.5-865	 Allen 4,0	 170.5-848	 170.5-850	 174.1-866
S40W CKUNR 16	40	37	27	450	48							

CKUNL



 Código  Code  Código	 Dimensão (mm)  Dimension  Dimensiones					 Inserto  Insert  Plaquita	 Componentes  Components		 Accesorios			
	d	h	f	l	D _{min.}		 Grampo L  Wedge L  Brida L	 Parafuso  Screw  Tornillo	 Chave  Wrench  Llave	 Mola  Spring  Resorte	 Calço L  Shim Left  Pl. Apoyo L	 Rebite  Shim Pin  Pasador
S32U CKUNL 16	32	30	22	350	44	KN__16	 170.5-824	 170.5-865	 Allen 4,0	 170.5-848	 170.5-850	 174.1-866
S40W CKUNL 16	40	37	27	450	48							









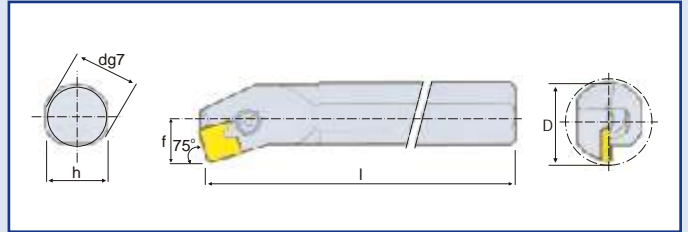
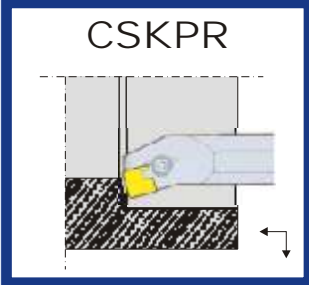





















 Fixação por Grampo

 Top Clamp Type

 Sujeción por Brida Superior









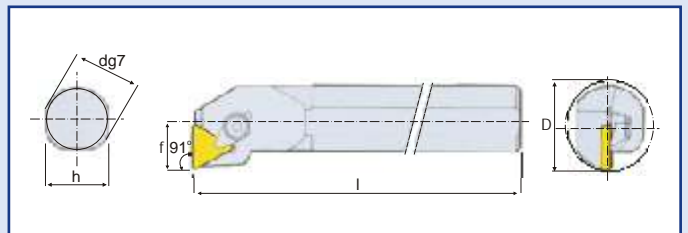
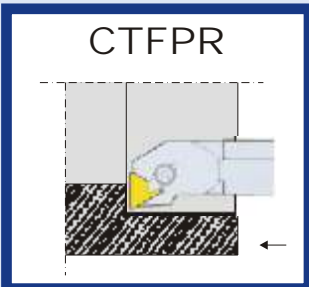

































CSKPR



 Código  Code  Código	 Dimensão (mm)  Dimension  Dimensiones					 Inserto  Insert  Plaquita	 Componentes		 Components		 Accesorios	
	d	h	f	l	D _{min.}		 Cj. Grampo  Wedge Set  Jg de Brida	 Chave  Wrench  Llave	 Calço  Shim  Placa de Apoio	 Rebite  Shim Pin  Pasador		
S16R CSKPR/L 09	16	15	11	200	20	 SP__09	 174.9-830-1	 Allen 2,5	 -	 -		
S20S CSKPR/L 09	20	18	13	250	25							
S25T CSKPR/L 12	25	23	17	300	32							
S32U CSKPR/L 12	32	30	22	350	40						 174.2-850	 174.1-865

CTFPR











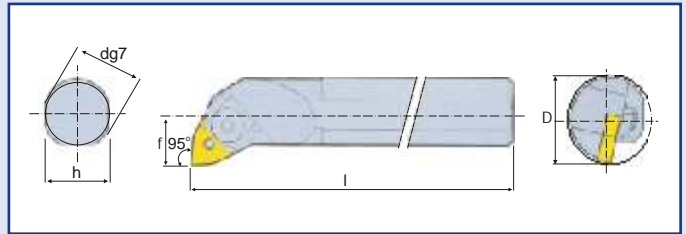
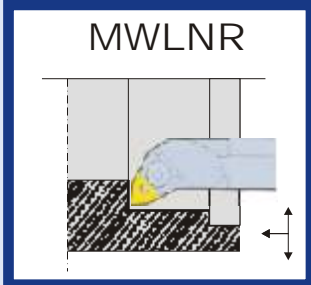









 Código  Code  Código	 Dimensão (mm)  Dimension  Dimensiones					 Inserto  Insert  Plaquita	 Componentes		 Components		 Accesorios	
	d	h	f	l	D _{min.}		 Cj. Grampo  Wedge Set  Jg de Brida	 Chave  Wrench  Llave	 Calço  Shim  Placa de Apoio	 Rebite  Shim Pin  Pasador		
S12M CTFPR/L 11	12	11	9	150	16	 TP__11	 172.9-826-1	 Allen 2,5	 -	 -		
S16R CTFPR/L 11	16	15	11	200	20							
S20S CTFPR/L 11	20	18	13	250	25		 174.9-830-1	 Allen 2,5	 -	 -		
S25T CTFPR/L 16	25	23	17	300	32		 TP__16	 174.9-832-1	 Allen 3,0	 -	 -	
S32U CTFPR/L 16	32	30	22	350	40							
S40U CTFPR 22	40	37	27	400	50							 175.2-850
						 174.9-832-2	 Allen 3,0	 175.2-850	 174.1-865			

 Fixação por Cunha-Grampo

 Wedge Clamp Type

 Sujeción por Brida Cuña



 Código  Code  Código	 Dimensão (mm)  Dimension  Dimensiones					 Inseto  Insert  Plaquita	 Componentes  Components		 Accesorios		
	d	h	f	l	D _{min.}						
S20S MWLNR/L 06	20	18	13	250	25	WN__06	5431.125-001	Allen 2,5	-	5313.022-02	-
S25T MWLNR/L 06	25	23	17	300	32	WN__08	5431.125-021	Allen 3,0	5322.331-09	5313.022-03	-
S25T MWLNR/L 08	25	23	17	300	32				5322.331-07		
S32U MWLNR/L 08	32	30	22	350	40						

DHR_{XL}

Ferramentas Técnicas e Com. Ltda.

FERRAMENTAS DE CORTE E EQUIPAMENTOS

Fone: (41) 3022-1919

Fax: (41) 3275-0853

dhr.ferramentas@gmail.com

www.dhrferramentas.com.br









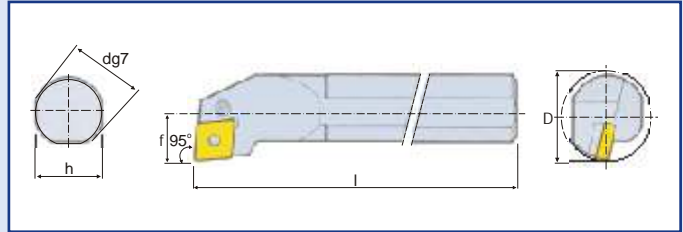
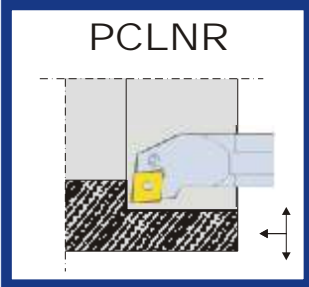







 Fixação por Alavanca

 Lever Lock Type

 Sujeción por Palanca









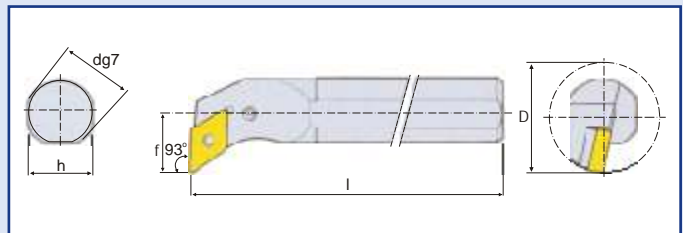
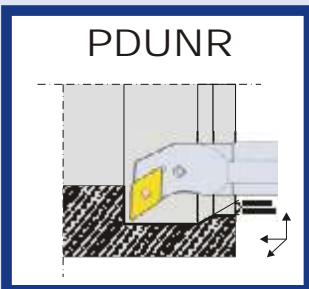

PCLNR



■ Código ■ Code ■ Código	■ Dimensão (mm)					■ Inserto ■ Insert ■ Plaqueta	■ Componentes		■ Components		■ Accesorios			
	■ Dimension						■ Alavanca		■ Parafuso		■ Chave		■ Calço	
	■ Dimensiones						■ Lever		■ Screw		■ Wrench		■ Shim	
■ Código	d	h	f	l	D _{min.}									
S16R PCLNR/L 09	6	15	11	200	20	CN__09			Allen 2,0	-				
S20S PCLNR/L 09	20	18	13	250	25									
S25T PCLNR/L 09	25	23	17	300	32									
S25T PCLNR/L 12	25	23	17	300	32	CN__12			Allen 2,5	-				
S32U PCLNR/L 12	32	30	22	350	40									
S40V PCLNR/L 12	40	37	27	400	50									
S50W PCLNR/L 16	50	47	35	450	63	CN__16			Allen 3,0	171.31-850M	174.3-861			
S50W PCLNR/L 19	50	47	35	450	63	CN__19			Allen 4,0	171.31-851M	174.3-868			

PDUNR



■ Código ■ Code ■ Código	■ Dimensão (mm)					■ Inserto ■ Insert ■ Plaqueta	■ Componentes		■ Components		■ Accesorios			
	■ Dimension						■ Alavanca		■ Parafuso		■ Chave		■ Calço	
	■ Dimensiones						■ Lever		■ Screw		■ Wrench		■ Shim	
■ Código	d	h	f	l	D _{min.}									
S25T PDUNR/L 11	25	23	17	300	32	DN__11			Allen 2,0	-				
S32U PDUNR/L 11	32	30	22	350	40									
S40V PDUNR/L 15	40	37	27	400	50	DN__15			Allen 3,0	171.35-851M	174.3-861			
S50W PDUNR/L 15	50	47	35	450	63									





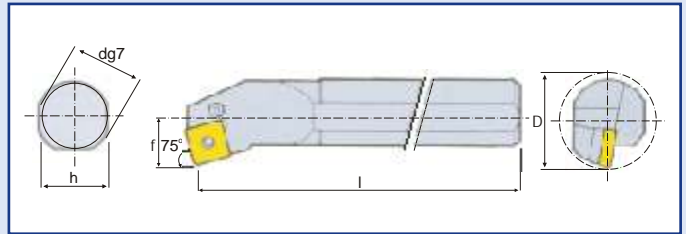
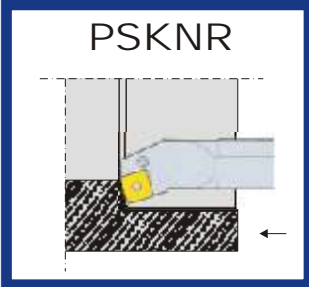

 Fixação por Alavanca

 Lever Lock Type

 Sujeción por Palanca







PSKNR

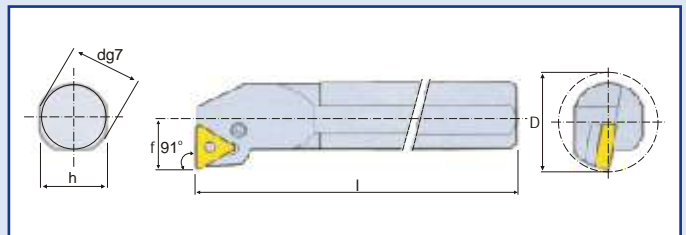
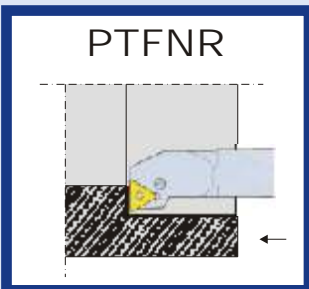

Código Code Código	Dimensão (mm) Dimension Dimensiones					Inserto Insert Plaquita	Componentes		Components		Accesorios	
	d	h	f	l	D _{min.}			 Alavanca Lever Palanca	 Parafuso Screw Tornillo	 Chave Wrench Llave	 Calço Shim Placa de Apoyo	 Rebite Shim Pin Pasador
								438.3-841-1	438.3-832	Allen 2,5	-	-
S25T PSKNR/L 12	25	23	17	300	32	SN__12	174.3-848M	174.3-858	Allen 3,0	174.3-851M	174.3-861	
S32U PSKNR/L 12	32	30	22	350	40		174.3-841M	174.3-821	Allen 3,0	174.3-851M	174.3-861	
S40V PSKNR/L 12	40	37	27	400	50							

PTFNR



Código Code Código	Dimensão (mm) Dimension Dimensiones					Inserto Insert Plaquita	Componentes		Components		Accesorios	
	d	h	f	l	D _{min.}			 Alavanca Lever Palanca	 Parafuso Screw Tornillo	 Chave Wrench Llave	 Calço Shim Placa de Apoyo	 Rebite Shim Pin Pasador
								174.3-846-1	174.3-829	Allen 2,0	-	-
S16R PTFNR/L 11	16	15	11	200	20	TN__11						
S20S PTFNR/L 11	20	18	13	250	25							
S25T PTFNR/L 11	25	23	17	300	32							







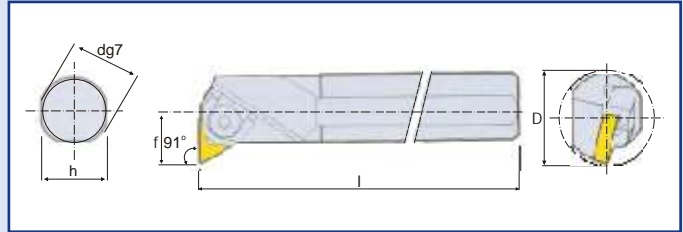
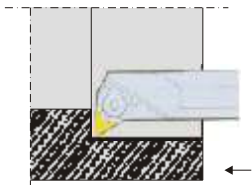

 Fixação por Alavanca

 Lever Lock Type

 Sujeción por Palanca

PTFNR-W



 Código  Code  Código	 Dimensão (mm)  Dimension  Dimensiones					 Inserto  Insert  Plaquita	 Componentes  Components		 Accesorios					
	d	h	f	l	D _{min.}									
S25T PTFNR/L 16W	25	23	17	300	32	TN_16	170.38.820-1	Allen 2,5	-	5313.021-01	5512.031-01			
S32U PTFNR/L 16W	32	30	22	350	40				170.3-852	5313.021-02				
S40V PTFNR/L 16W	40	37	27	400	50				170.3-855	5313.021-03		3212.100-206		
S50W PTFNR/L 16W	50	47	35	450	63				TN_22	170.38.821-1	Allen 3,0	170.3-855	5313.021-03	5512.031-02
S40W PTFNR/L 22W	40	37	27	400	50									
S50W PTFNR/L 22W	50	47	35	450	63									

■ Fixação por Parafuso

■ Screw Clamp Type

■ Sujeción por Tornillo

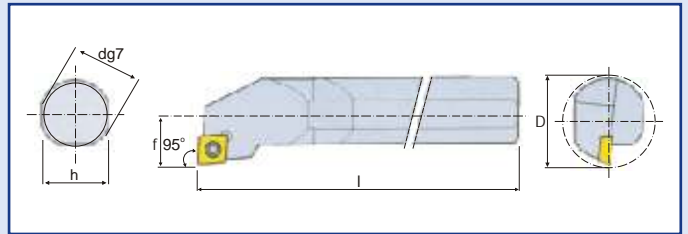
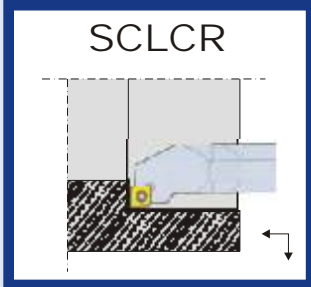

■ Código ■ Code ■ Código	■ Dimensão (mm)					■ Inserto ■ Insert ■ Plaqueta	■ Componentes ■ Components ■ Accesorios			
	■ Dimension						■ Parafuso ■ Screw ■ Tornillo	■ Calço ■ Shim ■ Placa de Apoio	■ Prf. Calço ■ Shim Screw ■ Tnll. Placa de Apoio	■ Chave ■ Key ■ Llave
	■ Dimensiones									
	d	h	f	l	D _{min.}					
S08K SCLCR/L 06	8	7	5	125	10	CC__06				
S10M SCLCR/L 06	10	9	7	150	12					
S12M SCLCR/L 06	12	11	9	150	16					
S16R SCLCR/L 06	16	15	11	200	20					
S16R SCLCR/L 09	16	15	11	200	20	CC__09	5513.020-09	-	-	Torx T15
S20S SCLCR/L 09	20	18	13	250	25		5513.020-09	-	-	Torx T15
S25T SCLCR/L 09	25	23	17	300	32		5513.020-10	5322.232-01	5512.090-01	Torx T15
S25T SCLCR/L 12	25	23	17	300	32	CC__12	5513.020-17	-	-	Torx T15
S32U SCLCR/L 12	32	30	22	350	40		5513.020-18	5322.232-02	5512.090-03	Torx T15
S40V SCLCR/L 12	40	37	27	400	50		5513.020-18	5322.232-02	5512.090-03	Torx T15

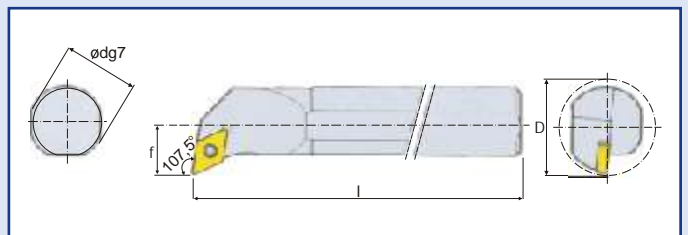
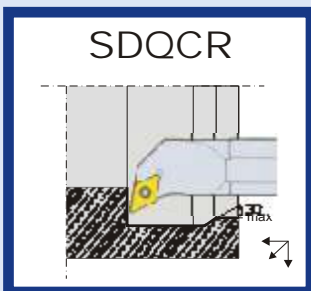

■ Código ■ Code ■ Código	■ Dimensão (mm)					■ Inserto ■ Insert ■ Plaqueta	■ Componentes ■ Components ■ Accesorios			
	■ Dimension						■ Parafuso ■ Screw ■ Tornillo	■ Calço ■ Shim ■ Placa de Apoio	■ Prf. Calço ■ Shim Screw ■ Tnll. Placa de Apoio	■ Chave ■ Key ■ Llave
	■ Dimensiones									
	d	h	f	l	D _{min.}					
S10M SDQCR/L 07	10	9	7	150	13	DC__07				
S12M SDQCR/L 07	12	11	9	150	16					
S16R SDQCR/L 07	16	15	11	200	20					
S20S SDQCR/L 11	20	18	13	250	25	DC__11	5513.020-09	-	-	Torx T15
S25T SDQCR/L 11	25	23	17	300	32		5513.020-10	-	-	

Fixação por Parafuso

Screw Clamp Type

Sujeción por Tornillo

SDUCR

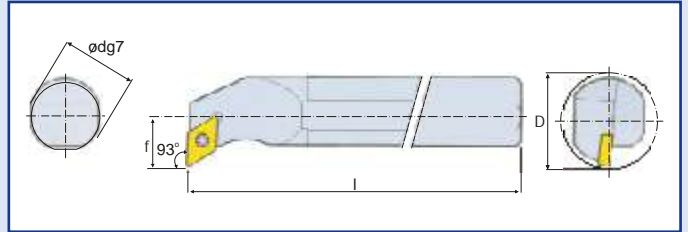
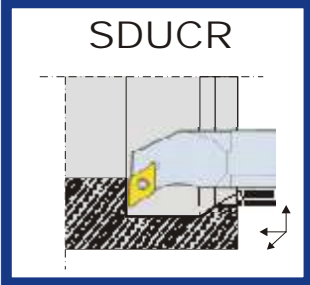

Código Code Código	Dimensão (mm) Dimension Dimensiones					Inserto Insert Plaquita	Componentes Components Accesorios				
	d	h	f	l	D _{min.}			Parafuso Screw Tornillo	Calço Shim Placa de Apoyo	Prf. Calço Shim Screw Tnl. Placa de Apoyo	Chave Key Llave
S10K SDUCR/L 07	10	9	125	7	13	DC__07	5513.020-03	-	-	Torx T7	
S12M SDUCR/L 07	12	11	150	9	16						
S16R SDUCR/L 07	16	15	200	11	20						
S16R SDUCR/L 11	20	18	250	13	25	DC__11	5513.020-09	-	-	Torx T15	
S20S SDUCR/L 11	25	23	300	17	32		5513.020-09	-	-	Torx T15	
S25T SDUCR/L 11	32	30	350	22	40		5513.020-10	-	-	Torx T15	
S32U SDUCR/L 11	16	15	200	11	20		5513.020-01	5322.263-02	5512.090-01	Torx T15	

SDZCR

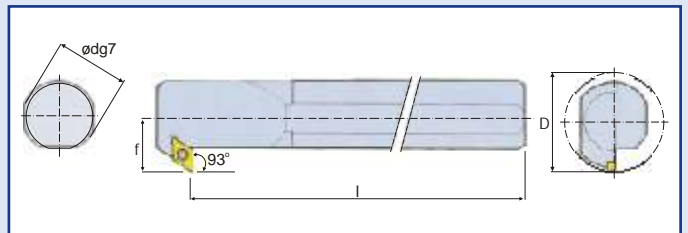
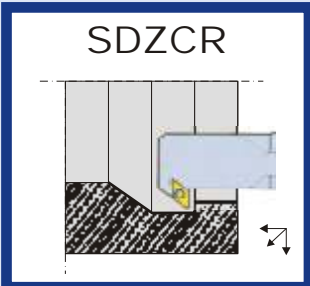

Código Code Código	Dimensão (mm) Dimension Dimensiones					Inserto Insert Plaquita	Componentes Components Accesorios				
	d	h	f	l	D _{min.}			Parafuso Screw Tornillo	Calço Shim Placa de Apoyo	Prf. Calço Shim Screw Tnl. Placa de Apoyo	Chave Key Llave
S16R SDZCR/L 07	16	15	13	200	22	DC__07	5513.020-03	-	-	Torx T7	
S20S SDZCR/L 07	20	18	15	250	27						
S25T SDZCR/L 07	25	23	18	300	33						
S32U SDZCR/L 11	32	30	22	350	40	DC__11	5513.020-01	5322.263-02	5512.090-01	Torx T15	

Fixação por Parafuso

Screw Clamp Type

Sujeción por Tornillo

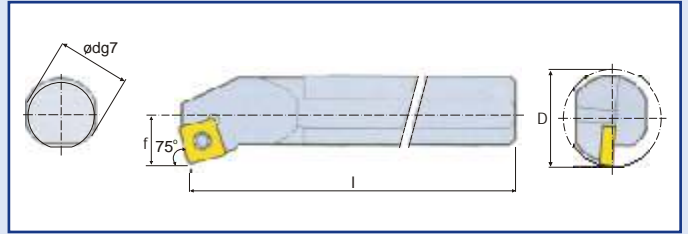
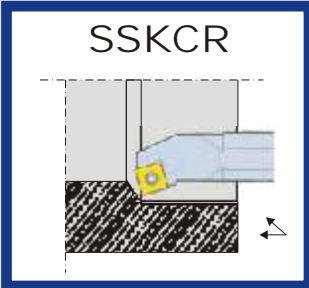

Código Code Código	Dimensão (mm) Dimension Dimensiones					Inserto Insert Plaqueta	Componentes Components Accesorios			
	d	h	f	l	D _{min.}		Parafuso Screw Tornillo	Calço Shim Placa de Apoio	Prf. Calço Shim Screw Tnll. Placa de Apoio	Chave Key Llave
							SC__09			
S16R SSKCR/L 09	16	15	11	200	20	SC__09	5513.020-09	-	-	Torx T15
S20S SSKCR/L 09	20	18	13	250	25	SC__12	5513.020-17	-	-	Torx T15
S25T SSKCR/L 12	25	23	17	300	32		5513.020-18	5322.420-02	5512.090-03	Torx T15
S32U SSKCR/L 12	32	30	22	350	40					

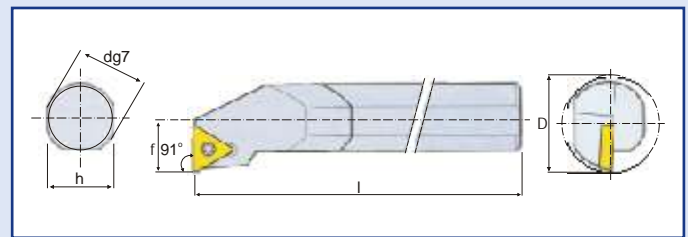
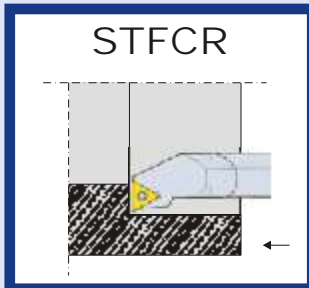

Código Code Código	Dimensão (mm) Dimension Dimensiones					Inserto Insert Plaqueta	Componentes Components Accesorios			
	d	h	f	l	D _{min.}		Parafuso Screw Tornillo	Calço Shim Placa de Apoio	Prf. Calço Shim Screw Tnll. Placa de Apoio	Chave Key Llave
							TC__06			
S06H STFCR/L 06	6	5	4,5	100	8,5	TC__06	5513.020-28	-	-	Torx T6
S08K STFCR/L 06	8	7	5	125	10	TC__09	5513.020-27	-	-	Torx T6
S10K STFCR/L 09	10	9	7	125	13		5513.020-05	-	-	Torx T7
S12M STFCR/L 09	12	11	9	150	16	TC__11				
S12M STFCR/L 11	12	11	9	150	16		5513.020-03	-	-	Torx T7
S16R STFCR/L 11	16	15	11	200	20					
S20S STFCR/L 11	20	18	13	250	25	TC__16	5513.020-10	-	-	Torx T15
S25T STFCR/L 16	25	23	17	300	32		5513.020-01	5322.320-01	5512.090-01	Torx T15
S32U STFCR/L 16	32	30	22	350	40					
S40V STFCR/L 16	40	37	27	400	50					

Fixação por Parafuso

Screw Clamp Type



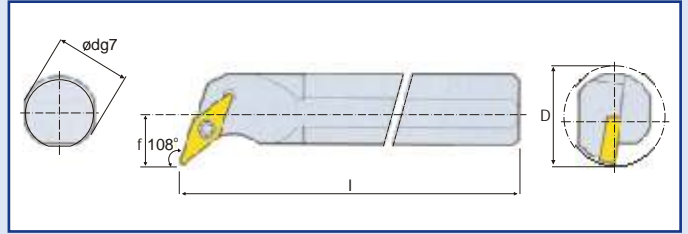
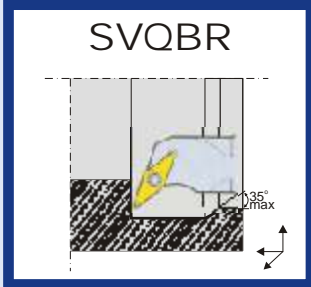



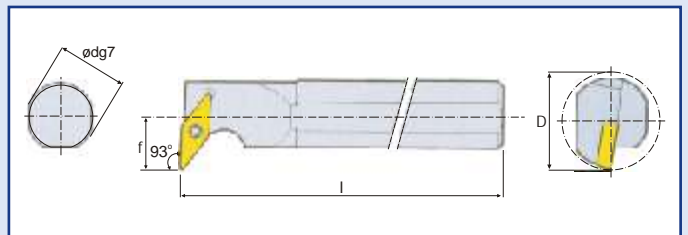
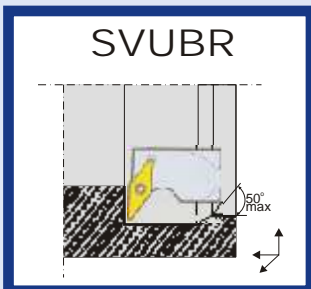

Sujeción por Tornillo

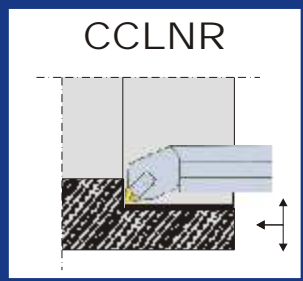
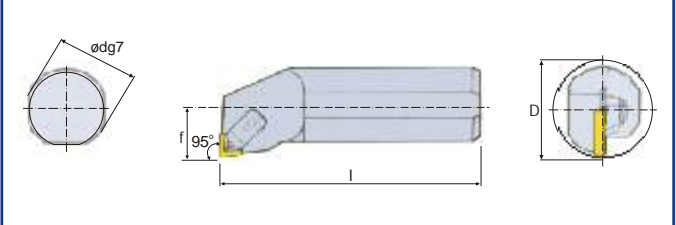







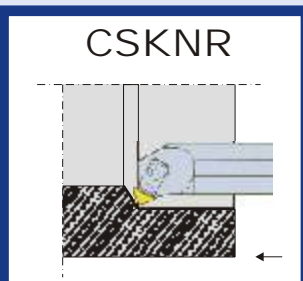
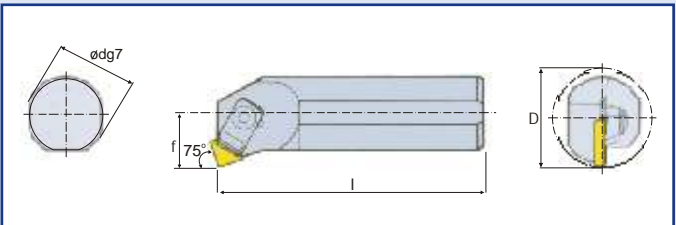

Código Code Código	Dimensão (mm) Dimension Dimensiones					Inserto Insert Plaquita	Componentes Components Accesorios			
	d	h	f	l	D min.		Parafuso Screw Tornillo	Calço Shim Placa de Apoyo	Prf. Calço Shim Screw Tnll. Placa de Apoyo	Chave Key Llave
S16R SVQBR/L 11	16	15	13	200	22	VB__11				
S20S SVQBR/L 11	20	18	15	250	27					
S25T SVQBR/L 11	25	23	18	300	33					
S25T SVQBR/L 16	25	23	18	300	33	VB__16				
S32U SVQBR/L 16	32	30	22	350	40					
S40V SVQBR/L 16	40	37	27	400	50					



Código Code Código	Dimensão (mm) Dimension Dimensiones					Inserto Insert Plaquita	Componentes Components Accesorios			
	d	h	f	l	D min.		Parafuso Screw Tornillo	Calço Shim Placa de Apoyo	Prf. Calço Shim Screw Tnll. Placa de Apoyo	Chave Key Llave
S16R SVUBR/L 11	16	15	13	200	22	VB__11				
S20S SVUBR/L 11	20	18	15	250	27					
S25T SVUBR/L 11	25	23	18	300	33					
S25T SVUBR/L 16	25	23	18	300	33	VB__16				
S32U SVUBR/L 16	32	30	22	350	40					
S40V SVUBR/L 16	40	37	27	400	50					

■ Código ■ Code ■ Código		■ Dimensão (mm) ■ Dimension ■ Dimensiones					■ Inserto ■ Insert ■ Plaquita	■ Componentes ■ Components		■ Accesorios			
		d	h	f	l	D _{min.}		■ Grampo ■ Clamp Set ■ Jg de Brida	■ Chave ■ Key ■ Llave	■ Calço ■ Shim ■ Placa de Apoio	■ Prf. Calço ■ Shim Screw ■ Tnll. Plc. de Apoio	■ Pino ■ Pin ■ Pasador	■ Chave 2 ■ Key 2 ■ Llave 2
CCLNR  													
S40T CCLNR/L 12		40	70	37	300	27	CNG__12	C125-02 R/L	Allen 4,0	WCN231	S013-02	P032-02	Allen 2,5
S50U CCLNR/L 12		50	70	47	350	32							

■ Código ■ Code ■ Código		■ Dimensão (mm) ■ Dimension ■ Dimensiones					■ Inserto ■ Insert ■ Plaquita	■ Componentes ■ Components		■ Accesorios			
		d	h	f	l	D _{min.}		■ Grampo ■ Clamp Set ■ Jg de Brida	■ Chave ■ Key ■ Llave	■ Calço ■ Shim ■ Placa de Apoio	■ Prf. Calço ■ Shim Screw ■ Tnll. Plc. de Apoio	■ Pino ■ Pin ■ Pasador	■ Chave 2 ■ Key 2 ■ Llave 2
CSKNR  													
S40T CSKNR/L 12		40	70	37	300	27	SNG__12	C125-02R/L	Allen 4,0	WSN-421	S013-02	P032-02	Allen 2,5

DHR_{XL}

Ferramentas Técnicas e Com. Ltda.

FERRAMENTAS DE CORTE E EQUIPAMENTOS

Fone: (41) 3022-1919 Fax: (41) 3275-0853

dhr.ferramentas@gmail.com
www.dhrferramentas.com.br